



Honor 100 Zoom is a new member of the Honor profile family. It's powered by an 100W 3200K or 5600K LED source with HD optics and bright output. Zoom lens available in 15° - 30°. The fixture comes with high CRI over 94, CQS over 91.

Key features:

- 100W COB white LED
- 3200K or 5600K color temperature
- CRI 94, CQS over 91
- HD optical system, clean shutter cuts beam
- 15° - 30° zoom lens, single side zoom
- Flicker free with selectable PWM
- Rotary, key, DMX control of dimmer
- Intelligent fan, silent operation for studio and theatre use
- Super compact body, only 3.5 kg, easy to install and setup
- Powercon T1 in, DMX in & out

Application:

- Broadcast, HD studio
- Theatre, church
- Fashion show
- Museum
- Exhibition

Accessories:

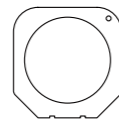

Gel frame

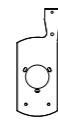

Gobo holder (opt.)

HONOR 100 ZOOM

WW / CW

300W LED profile zoom

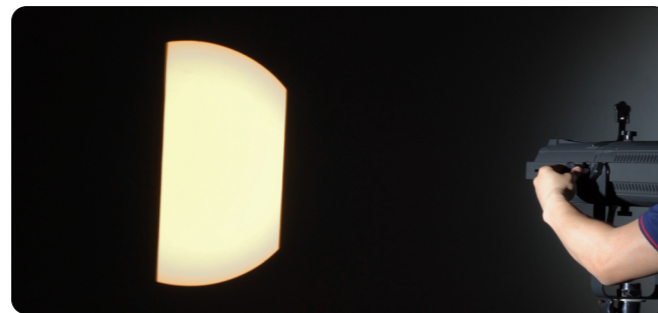

Photometric

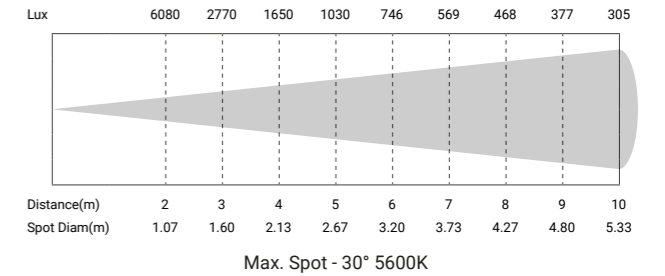
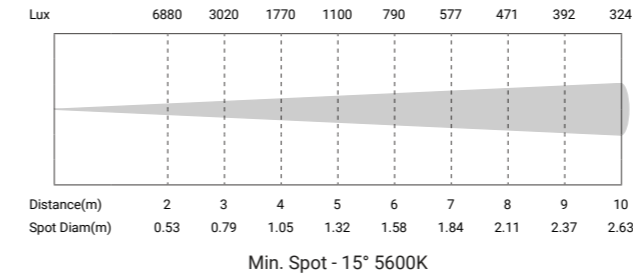

Color Rendition

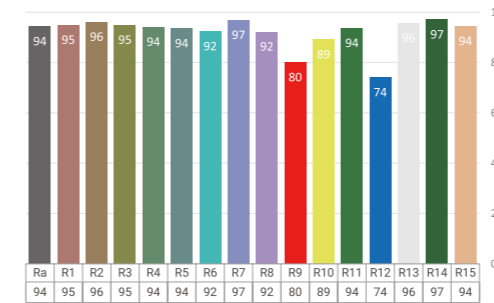

Technical Data

| | |
|--------------------|----------------------------------|
| Power supply: | AC100 - 240V, 50/60Hz |
| Light source: | 100W COB LED |
| Color temperature: | 3200K or 5600K |
| Zoom range: | 15° - 30° manual zoom |
| Color Rendition: | CRI 94, TLCI 97, CQS 91(5600K) |
| Power connection: | PowerCON T1 in |
| Signal connection: | 3-pin XLR in & out |
| Control channels: | 1/2/3 |
| Control mode: | Rotary, DMX, RDM |
| Housing: | Color black, engineering plastic |

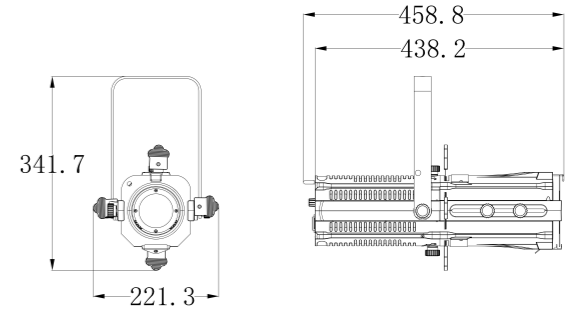

| | |
|---------------------|---|
| Size: | 459 x 221 x 342mm |
| Package(carton): | 560 x 280 x 330mm |
| N.W.: | 3.5 kg |
| G.W.: | 5 kg |
| Accessories(incl.): | Power cable, gel frame, Safety rope |
| Accessories(opt.): | Gobo holder, Clamp, Y split power cable |
| GOBO Size: | OD 38mm, 1.2mm thickness |
| Compliance: | Pending |
| Environment: | IP20 |

THEATRICAL LIGHTING

THEATRICAL LIGHTING